

# DTCM71M-80H-AL

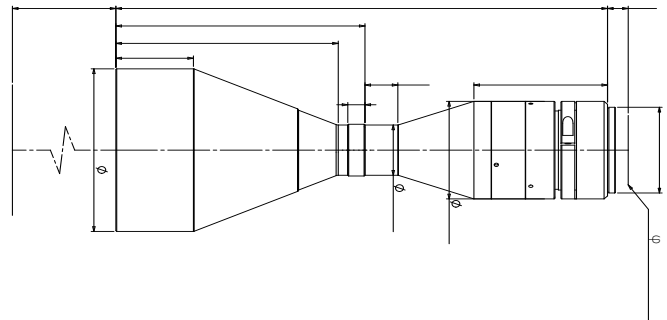

80  
0.488  
228±4  
39  
6.6  
>130  
±2.7@F16  
<0.1  
<0.1  
525±4



M58 or other  
285.2  
2.5